

**Geared/Geared+Brake/Rotary actuator/Rotary actuator+Brake type
5-phase stepping motor(AK/AHK series)**

■ Dimensions

*This dimension is for dual shaft type. There is no shaft at sectioned B(-----) part in single shaft type.

Unit:mm

□42

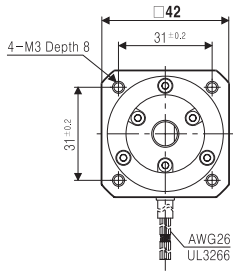

Sectioned A-A'

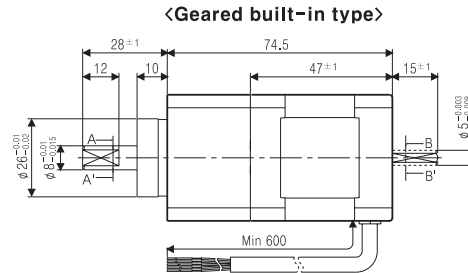

Sectioned B-B'

□60

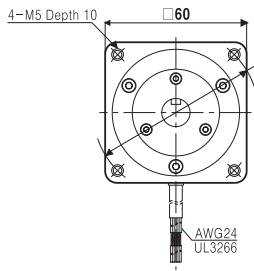

Sectioned A-A'

Parallel KEY

<Geared built-in type>

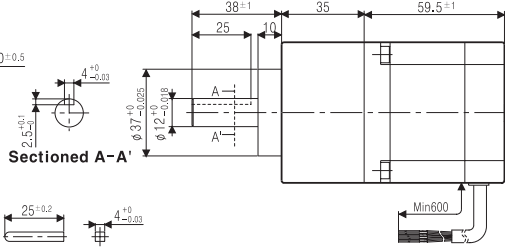

<Geared+Brake built-in type>

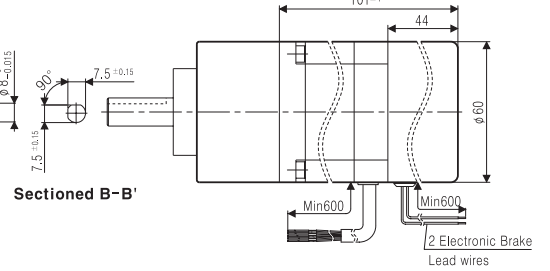

□60

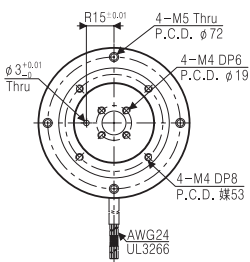

<Rotary actuator type>

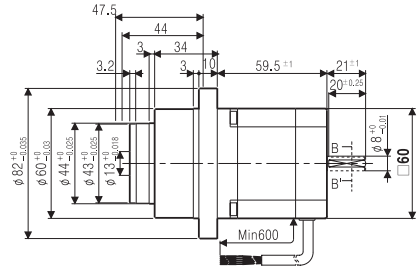

<Rotary actuator+Brake built-in type>

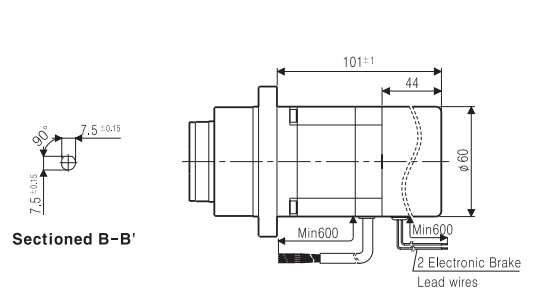

□85

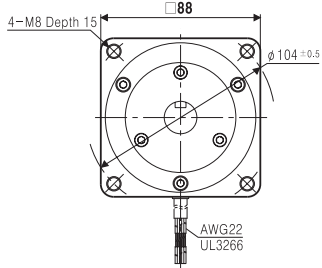

Sectioned AA'

Parallel KEY

<Geared type>

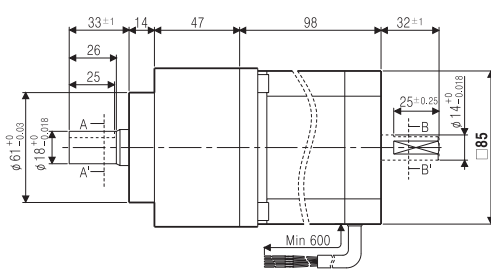

Sectioned BB'

<Geared+Brake built-in type>

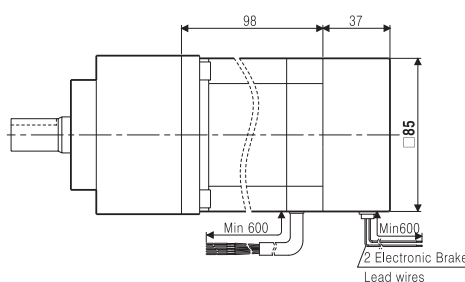

* Brake is non-polar type "B".
Be careful not to exceed the rated voltage (24VDC).
* Switch1 ON : Brake is released.
Switch1 OFF : Brake is ON

Counter
Timer
Temp. controller
Power controller
Temp./ Humidity transducer
Thermo couples & RTD
Panel meter
Tacho/ Speed/ Pulse meter
Display unit
Serial converter module
Graphic panel
Sensor controller/ Switching power supply
Proximity sensor
Photo electric sensor
Pressure sensor
Rotary encoder

Stepping motor & Driver & Controller